

Festival Nacional de Robótica - Portuguese Robotics Open

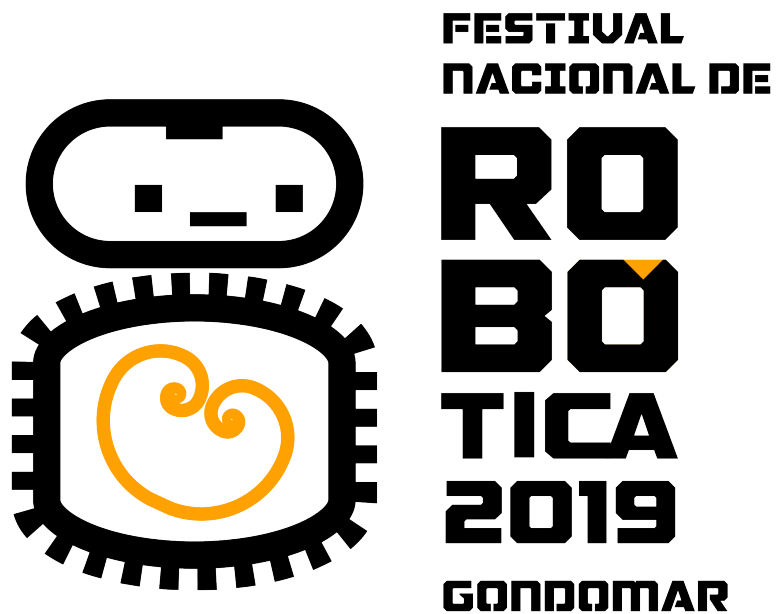

Rules for Autonomous Driving



Sociedade Portuguesa de Robótica

2019

Contents

1	Introduction	1
1.1	Changes from previous years	1
2	Rules for Robot	2
2.1	Dimensions	2
2.2	Autonomy	2
2.3	Security	2
3	Rules for Competition Area	4
3.1	Track	4
3.1.1	Dimensions	4
3.1.2	Colors	4
3.1.3	Zebra Crossing	4
3.1.4	Starting and arrival zones	6
3.1.5	Parking areas	6
3.2	Obstacles	6
3.3	Working Zone	7
3.4	Signaling Panels	7
3.4.1	Setup	7
3.4.2	Indicating signals	8
3.5	Vertical Traffic Signs	9
3.5.1	Description	9
3.5.2	Types of vertical traffic signs	9
3.5.3	Signaling method	9
4	Rules for Competition	11
4.1	Objectives	11
4.2	Organization	11
4.3	Challenges	11
4.3.1	Driving challenges	11
4.3.2	Parking challenges	12
4.3.3	Vertical traffic signs detection challenge	12
4.4	Rounds	12
4.5	Scoring	13
4.6	Penalties	14
4.7	Competition Classes	14

1 Introduction

The Autonomous Driving Competition is a competition for fully autonomous robots that takes place in a track with the shape of a traffic road, surrounded by two parallel side lines and including two lanes separated by a dashed mid line (see Figure 3.1). The competition, starting in 2011, includes two independent classes designated “Rookie Class” and “Expert Class”. Each of these classes has its specific set of rules and particular competition organization, that also corresponds to different levels of challenge and difficulties to overcome.

1.1 Changes from previous years

The rule-set for year 2019 is the same as previous years except that the tunnel challenge is removed and the working area is slightly altered.

2 Rules for Robot

2.1 Dimensions

The robot has to fit entirely into a rectangular parallelepiped box 60cm wide, 100cm long and 80cm high (these values have an accuracy of $\pm 1\%$).

2.2 Autonomy

The robot is a completely autonomous vehicle. All decisions are taken by the systems included in it and all of its energy sources must also be embedded there. Competitors are not allowed to include radio or infrared devices to establish any kind of communication between the robot and other electronic devices external to it.

2.3 Security

The robot must have adequate security mechanisms according to its power and mode of locomotion so that it can stop itself in situations that may pose any sort of danger to people or property. In particular, the robot must provide a connector by means of which the power to the motors can be disconnected through an externally controlled relay (dry contact). This connector is mandatory, except if the team can demonstrate that the maximum speed of the robot is low enough so that no danger to people or property can be produced. Is the Jury competence to decide if the team can or can not be allowed to compete without the security device.

The power switching device (see diagram) is provided to the team by the organization at the start of its race test and can be remotely actuated through a radio-frequency (RF) link. In turn, this RF device is exclusively handled by the referee, who will determine the circumstances under which the robot must be immobilized. The power switching device is placed inside a box with $100 \times 80 \times 50$ (mm), which must be attached to the robot through a 20×80 (mm) Velcro strip. An adequate space for this purpose must be provided in the contestant robot. The Velcro strip placed in the robot should be of the female type.

2 Rules for Robot

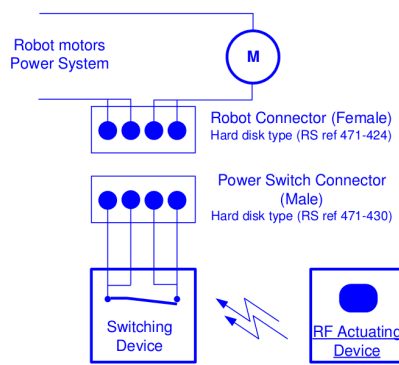

Figure 2.1: Electrical schematic of the power switch device.

3 Rules for Competition Area

3.1 Track

3.1.1 Dimensions

The competition track is placed within an area of (6.95 x 16.7) m, has the format of a traffic road and is surrounded by two parallel side lines. A representative view of this route is shown in Figure 3.1. The radii of curvature of the inner and outer curved paths are 1.50m and 3.05m respectively. The straight leg is 10.60m long. The distance between lines, measured between their inside limit, is 150cm. The lines themselves are 5cm wide. At the centre of the runway there is a dashed line that divides the track into two equal side bands. The white sections of this dashed line are 5cm wide by 20cm long and are evenly spaced by 15cm. All data regarding the key measures of the track, zebra crossing and parking areas is shown in Figure 3.2.

3.1.2 Colors

The track floor is dark and infrared absorbing. The side lines are white and are infrared reflective. The area outside the track, but adjacent to the external lines, forms a band at least 20cm wide, and uses the same color of the track floor.

3.1.3 Zebra Crossing

A walking zebra crossing is placed roughly at the centre of the straight leg, and at the junction of the two circular sections, as represented in Figure 3.3. The “zebra” area consists of seven white stripes with a size of 10x30cm, and spaced 10cm from each other. This area is placed 10cm away from the track outside delimiting lines. The zebra crossing

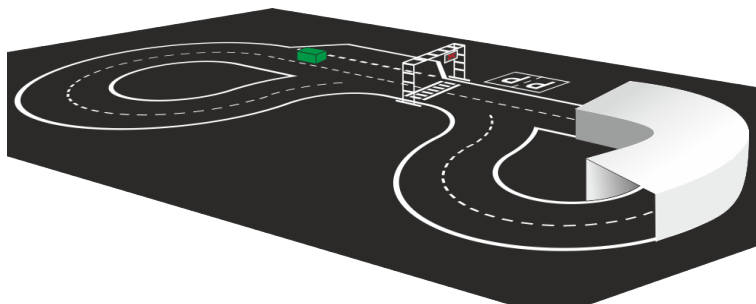

Figure 3.1: Track overview - please note: tunnel removed from the 2019 rule-set

3 Rules for Competition Area

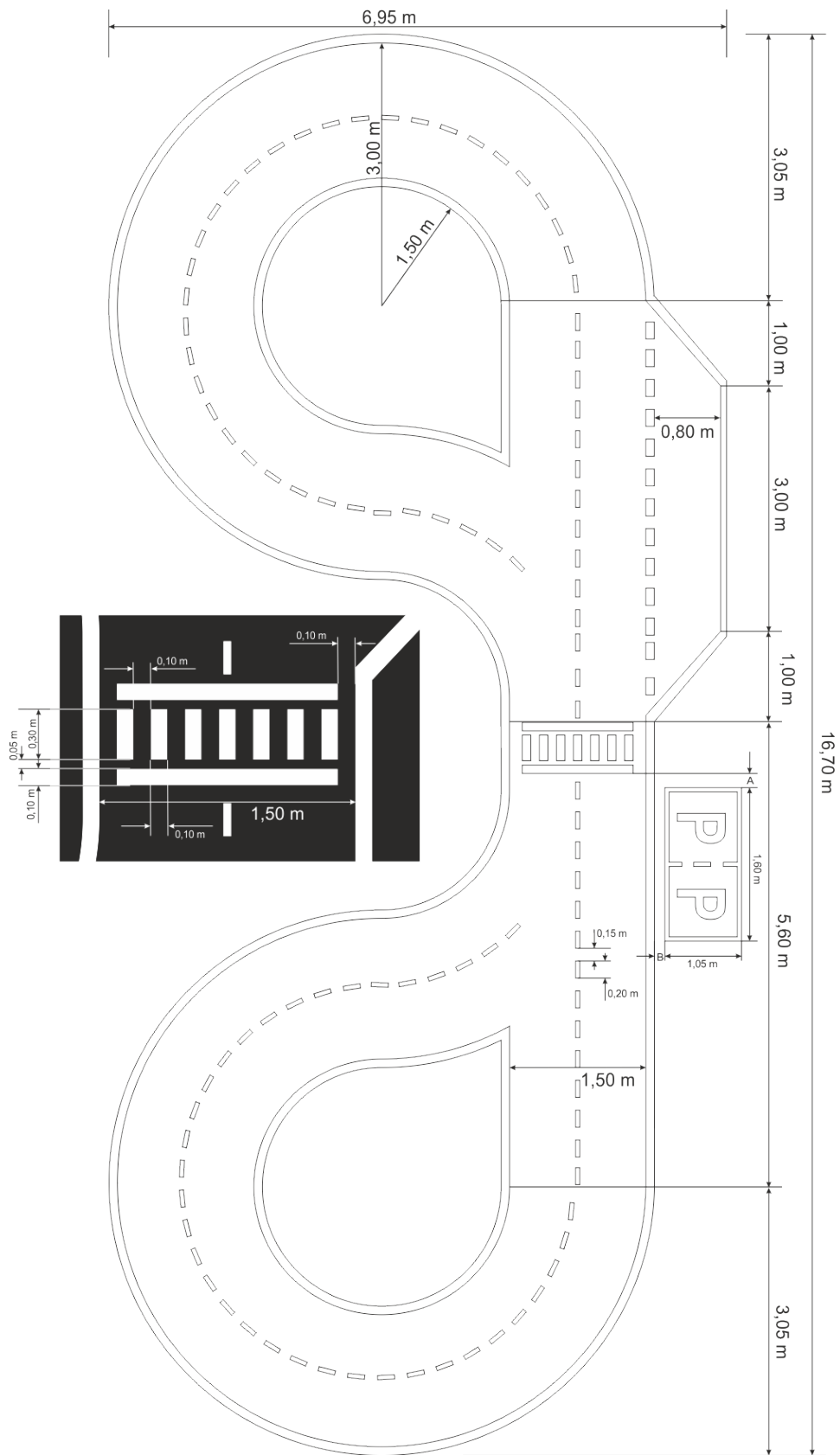

Figure 3.2: Track dimensions

3 Rules for Competition Area

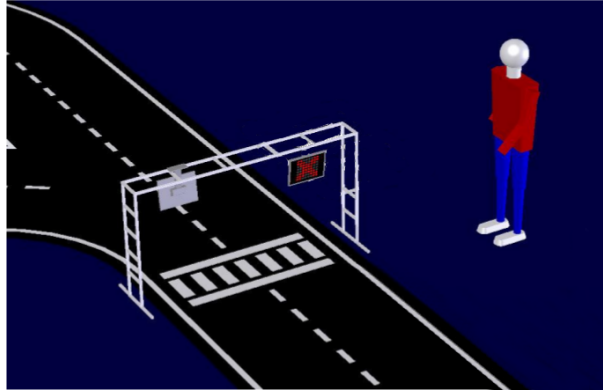

Figure 3.3: Zebra crossing and start/arrival zone

is limited on both sides by two white lines with 10x130cm (centered on the runway). All traces of this zebra crossing are infrared reflective.

3.1.4 Starting and arrival zones

An area immediately prior to the zebra crossing, but intercepting its first cross line, is assumed to be the departure/arrival zone, when considering the direction of movement of the robot. This is set in accordance with the rules further explained in the “competition” chapter.

3.1.5 Parking areas

There are two parking areas. One, is located right after the zebra crossing, on its right side when considering the robots starting direction. It consists of a band, parallel to the right driving band and with the same width. The other parking area, is a bay parking zone, with two places, located right before the zebra crossing and on its right side when considering the robots starting direction. It consists of two contiguous rectangles where the letter “P” is inscribed. The distance between the park side closest to the track and the track external line (B distance in figure 3.2) will be 20 cm \pm 50%. The maximum distance between the zebra crossing and the start of the park (A distance in figure 3.2) may vary between 50 cm and 200 cm. Other measurements can be found in figure 3.2.

3.2 Obstacles

In some of the challenges, obstacles will be placed on the track. Robots are expected to detect and avoid colliding with them. An obstacle is a rectangular parallelepiped box with a 60cm square base and a minimum height of 20cm. The obstacle will be green colored. A placement example of this obstacle can be seen in Figure 3.4

The obstacle position on the track can vary between trials for the same robot, and is the jury responsibility to determine this obstacle location. The obstacle will never be placed inside the zebra crossing or inside a working zone path.

3 Rules for Competition Area

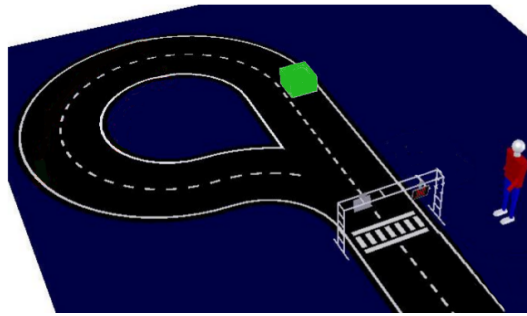

Figure 3.4: Obstacle placing example

3.3 Working Zone

The working zone (see Figure 3.5) reflects a detour from the original route of the track. This working zone has a length and form previously unknown to the teams, and its actual placing is revealed by the organization only after all robots are placed in closed park. The working zone can be coincident either with a curve zone or with a straight leg of the original pathway. This working zone path can extend away from the original route either to its outside or inside, and then returns to the original path. The working zone is delimited by orange and white cones (adapted from those used in work performed on actual roads). The alternative path will be at least 1m wide and bounded on the left and right by a sequence of cones, spaced approximately between 0.5m and 1m from each other.

3.4 Signaling Panels

3.4.1 Setup

Two TFT panels will be mounted right above the zebra crossing, in the inverted position, and vertically aligned with each one of the driving bands of the track. These panels will be used to show indicating signals to the competing vehicles.

The panel shall present itself to the robot on the right side of the track, considering the direction of its movement. The base of the panels will be 87 cm above the ground ($\pm 2\%$)

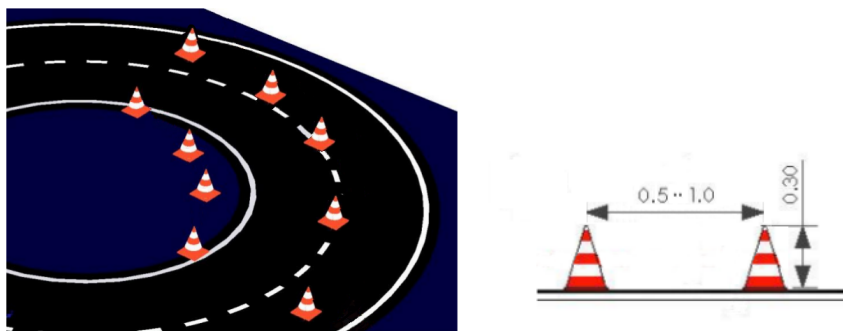

Figure 3.5: Working zone: example and cone dimensions

3 Rules for Competition Area

and its angle regarding the vertical plane will be of 25° (see Figure 3.6). The signaling panels will be mounted on an aluminum structure adequate for this purpose. Given the high placement of these panels and depending on the site lighting conditions a set of opaque devices may be placed, in order to minimize the effects resulting from the impact of direct light.

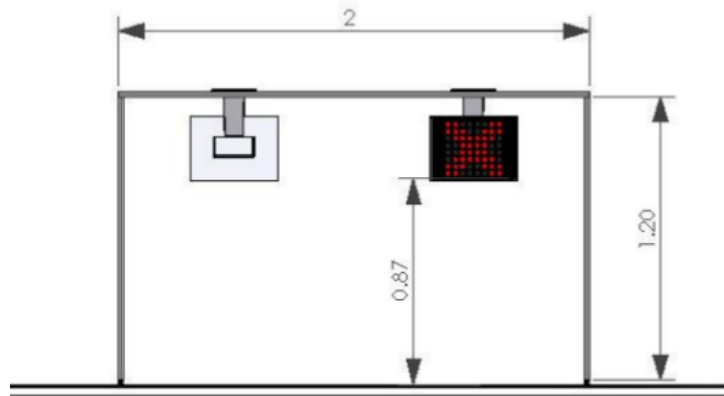

Figure 3.6: signaling panels: dimensions.

3.4.2 Indicating signals

The indicating signals presented on the TFT are shown in figure 3.7. The symbols themselves are displayed over a black background and are bounded by a square box. The files for each of the images can be found on the FNR site.

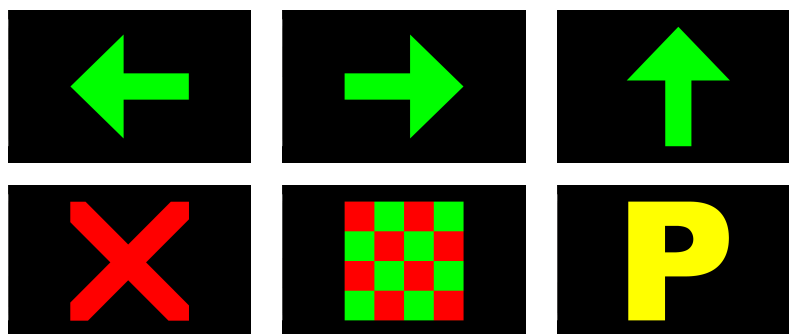

Figure 3.7: Signaling panel drawings. In the checkers flag, colours are presented in an alternate succession.

The aim of the signaling panels is to conduct the robots trials, giving them orders to stop, follow straight ahead, follow to the left, follow to the right, end of trial, and follow to parking area.

The correspondence between each of these functions and the information presented in the signaling panels is:

3 Rules for Competition Area

Function	Action	Signal
1	Follow to the left	A left pointing green horizontal arrow
2	Follow to the right	A right pointing green horizontal arrow
3	Follow straight ahead	A green colored vertical arrow
4	Stop	A red colored "X"
5	End of trial	Red and green checkers flag
6	Follow to parking area	A yellow colored "P"

3.5 Vertical Traffic Signs

3.5.1 Description

Twelve different traffic signs will be available for the competition. Their dimensions are limited by a bounding square of 305x305mm (equivalent to a 17" diagonal) standing on a post at 87cm from the ground. This is equivalent, in terms of size and height, to the TFT of the signaling panels. The base of the sign (305mmx200mm) will be placed 10cm away from the side line (Figure 3.8). Both the base and the post are painted white. The signs present themselves to the robot on the right side of the track, considering the robot direction of movement.



Figure 3.8: Example of a traffic sign placed on the side of the track.

3.5.2 Types of vertical traffic signs

Four of the vertical traffic signs will be warning signs (triangular shape), four will be mandatory signs (round shape), and the other four will be information or services signs (square shape). The selected traffic signs for the 2019 edition of the competition are the ones shown in Figure 3.9. Signs are marked with a pair of digits, one representing the sign type and the other a sign number within the type.

3.5.3 Signaling method

All robots facing the traffic signs challenge should be equipped with a way to show the signs they have detected and identified. Identification display must be done by the robot within a runway zone called validation area, which starts 1.5 meters before the traffic sign end ends 1.5 meters after this same sign.

3 Rules for Competition Area

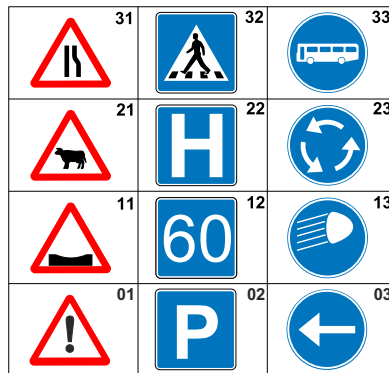

Figure 3.9: The twelve traffic signs selected to the 2019 edition of the competition.

Two possible display methods are presented here, but others can be allowed if previously accepted by the local organization:

- The robot can be equipped with three leds, of colors GREEN, RED and BLUE (alternatively a single three color led can be used). These leds are intended to show that the robot has detected and identified a traffic sign. The red led must be used to identify a warning sign, the blue led to identify a mandatory sign and the green led to identify an information sign. These leds must be turned ON once, for 1 second, to identify traffic signal 1, twice (1 second ON, 1 second OFF, and 1 second ON again) to identify traffic signal 2, and following the same sequential approach for traffic signals 3 and 4. Leds must be bright enough to be clearly visible from a 5 meter distance.
- Robots using a laptop (or possessing a display) can use the display to show the identified sign. The display should be used to either show an image of the detected sign or a color spot functioning like the leds referred in the previous point.

4 Rules for Competition

4.1 Objectives

The aim of the competition is to accomplish a set of different challenges. Each challenge has the purpose of evaluate some driving skills. The final team score is the sum of the best scores obtained in each one of the different challenges.

4.2 Organization

The competition is organized in a set of four rounds. Each round is organized in time slots of 10mn each, one per team. It is the team's responsibility to manage their time interval, choosing what challenges to face and in what order. Some challenges are available in more than one round. However, the number of trials per challenge is limited to three. For each challenge, only the trial with the best score will be taken into account.

The competition is divided into two classes, named **Rookie** and **Expert**. Teams from the two classes compete together, but scoring will be different. See section 4.7 for details.

4.3 Challenges

For the 2019 edition, the challenges belong to three different categories: driving challenges, parking challenges and vertical traffic sign detection challenges. There are four different challenges in the driving category (denoted D1 to D4), four in the parking category (denoted P1 to P2 and B1 to B2) and a single one in the vertical traffic sign detection category (denoted V1).

4.3.1 Driving challenges

In all the driving challenges, the aim of the competition is to complete a double lap around the track, starting from the area of departure/arrival and reaching the same area in the shortest possible time and with the least possible penalties. There are four different challenges in the driving category, referred to as **driving at pure speed**, **driving with signs**, **driving with signs plus obstacles**, **driving with all**.

- In the **driving at pure speed challenge (D1)**, the signaling panel is only used to trigger the robot departure, by changing from the Stop sign to the Follow straight ahead sign.

4 Rules for Competition

- In the **driving with signs challenge (D2)**, the robot must obey the indications provided by the signaling panels.
- In the **driving with signs and obstacles challenge (D3)**, in addition to the signaling panels, two obstacles will be placed in the second half of the track, one in each lane and in unknown locations at advance.
- Finally, in the **driving with all challenge (D4)**, the two obstacles are placed in the first half and a road working area is added to the second one..

4.3.2 Parking challenges

In the track, there are two parking zones, referred to as **parallel parking zone** and **bay parking zone**, placed ahead and behind the departure/arrival area, respectively. In all the parking challenges, the aim of the competition is to stop the robot within the parking zone, without incur in penalties. The follow to parking area indicating signal is used to trigger the robot departure.

There are two different challenges in the parallel parking sub-category, referred to as **parallel parking without obstacles (P1)** and **parallel parking between obstacles (P2)**. The location of the obstacles are not known in advance, except that, the distance between the obstacles will be twice the competing robot's length. In these challenges, the robots must stop parallel to the driving lane.

There are two different challenges in the bay parking sub-category, referred to as **bay parking without obstacles (B1)** and **bay parking with obstacle (B2)**. In the latter case, the parking place with the obstacle is not known in advance. The bay parking challenges must start immediately after a lap driving. This lap can be the second one of a driving challenge, the second one of the traffic signs detection challenge, or one done specifically for the bay parking challenge.

4.3.3 Vertical traffic signs detection challenge

In the **vertical signs detection challenge (V1)**, six vertical traffic signs (two per type), from the twelve shown in figure 3.9, will be placed along and aside the track, and the aim of the competition is to detect and identify the vertical signs while driving along the track.

The signaling panel is only used to trigger the departure of the robot, similar to driving challenge D1. The number of laps allowed to complete the challenge is limited to two.

4.4 Rounds

As stated before, the competition is organized in four rounds and each team has a 10mn time slot in each round. There is some flexibility in how a team can manage their time slot. They can choose what challenges to face from a set o available challenges. Also, some of the challenges can be tried in more than one round. Table 4.1 presents, for each round, the set of available challenges.

4 Rules for Competition

Table 4.1: Challenges available in each round.

Round	Challenge id								
	D1	D2	D3	D4	P1	P2	B1	B2	V1
round 1	yes	no	no	no	yes	yes	yes	yes	yes
round 2	yes	yes	no	no	yes	yes	yes	yes	yes
round 3	yes	yes	yes	no	yes	yes	yes	yes	yes
round 4	yes	yes	yes	yes	yes	yes	yes	yes	yes

However the following constraint apply: challenges D1, D2, D3 and V1 can be faced in round 4, if the team assume to not participate in challenge D4 in that round.

4.5 Scoring

As stated above, the final score of a team is the sum of the best scores obtained in all the challenges.

For the driving challenges, the number of completed half laps, the time taken to complete them and suffered penalties are taken into account to calculate the score. It is given by equation

$$score = n * S_r + (n * T_r - time) - penalties \quad (4.1)$$

where n is number of completed half laps, S_r is the reference score for a half lap, T_r is the reference time for a half lap, $time$ is the time taken by the robot to complete the n half laps, and $penalties$ is the summation of penalties suffered during the trial. If the resulting score is negative, it resets to 0, so competing in a challenge is never worse than not competing. The reference scores and reference times for the four driving challenges are shown in table 4.2.

Table 4.2: Reference scores and reference times per half lap for the driving challenges.

Challenge	Id	Reference score	Reference time
Driving at pure speed	D1	50	30
Driving with signs	D2	50	35
Driving with signs and obstacles	D3	50	40
Driving with all	D4	50	45

For the parking challenges, the score is given by equation

$$score = S_r - penalties \quad (4.2)$$

where S_r is the reference score for the challenge and $penalties$ is the summation of penalties suffered during the trial. The reference scores for the five parking challenges are shown in table 4.3.

Finally, for the vertical traffic signs detection challenge, the score is given by

$$score = n_t * S_t + n_n * S_n - penalties \quad (4.3)$$

4 Rules for Competition

Table 4.3: Reference scores for the parking challenges.

Challenge	Id	Reference score
Parallel parking without obstacles	P1	60
Parallel parking between obstacles	P2	60
Bay parking without obstacles	B1	60
Bay parking with obstacle	B2	60

where n_t and n_n are the number of signs whose type and number were correctly identified, S_t and S_n are the reference scores for sign type and sign number identification, and *penalties* is the summation of penalties suffered during the trial.

Table 4.4: Reference scores for the vertical signs detection challenge.

Challenge	Id	Reference score
Sign type correctly identified	V1	25
Sign number correctly identified	V1	25

4.6 Penalties

Table 4.5 presents a summary of all the infractions a robot can incur in and the penalties applied in such situations.

Table 4.5: Possible infractions and associated penalties.

Infraction	Penalty (s)	Related effect
Manual triggering of the departure	25	—
Early departure	25	—
Going outside of the track (partial)	10	—
Going outside of the track (total)	20	Trial termination
Stopping outside the stopping area	10	—
Wrong direction at the signalling panels	25	—
Non stopping at the stop sign	60	—
Early departure at the stop sign	25	—
Small collision with track accessories	10	—
Collision with track accessories altering geometry	20	Trial termination
Irregular parking manoeuvre (out of bounds)	10	—
Irregular parking manoeuvre (out of alignment)	10	—
Early parking manoeuvre	10	—

4.7 Competition Classes

All the challenges described above are assigned to the **Expert** class. For the **Rookie** class the following modification apply:

4 Rules for Competition

- Starting of the trial can be done manually in all the challenges.
- Challenges D2, D4, V1, and B2 are not included.
- In challenge D3, the robot doesn't have to obey the indications provided by the signalling panels.
- In the driving challenges (D1 and D3), the team has a maximum of five attempts per challenge, with at most three per round.

— End of document —