

Stochastic network-constrained co-optimization of energy and reserve products in renewable energy integrated power and gas networks with energy storage systems

Mohammad Amin Mirzaei^{1,2}, Ahmad Sadeghi Yazdankhah¹, Behnam Mohammadi-Ivatloo², Mousa Marzband³, Miadreza Shafie-khah⁴, João P. S. Catalão^{5,6}

¹Department of Electrical Engineering, Sahand University of Technology, Tabriz, Iran

²Faculty of Electrical and Computer Engineering, University of Tabriz, Tabriz, Iran

³Department of Mathematics, Physics and Electrical Engineering, Northumbria University, Newcastle, England

⁴School of Technology and Innovations, University of Vaasa, 65200 Vaasa, Finland

⁵INESC TEC and Faculty of Engineering of the University of Porto, 4200-465 Porto, Portugal

⁶INESC-ID, Instituto Superior Técnico, University of Lisbon, 1049-001 Lisbon, Portugal

Abstract

Increasing penetration of variable nature wind energy sources (WES) due to environmental issues, impose several technical challenges to power system operation as it is difficult to predict its output power because of wind intermittency. Power generation based on gas turbine with fast starting fitness and high ramping could better deal with inherent uncertainties comparing to other power generation sources. Considering natural gas network constraints impacts flexibility and participation of gas-fueled generation units on reserve and energy markets. Hence, the use of flexible energy storage system can reduce renewable sources alternation and the gas network limitation effects on power system operation cost. This paper proposes a two-stage stochastic network-constrained unit commitment based market clearing model for energy and reserve products in coordinated power and gas networks with the integration of compressed air energy storage (CAES) and WES. A six-bus electric system with a six-node gas system and IEEE reliability test system (RTS) 24-bus electric system with a ten-node gas network are considered to perform numerical tests and demonstrate the performance of the proposed model. The effect of including the constraints of the gas system on the power system operation cost in day-ahead co-optimization of energy and reserve products is evaluated

using numerical studies. Also, including CAES reduces the power system operation cost, load shedding and wind spillage.

Keywords: Day-ahead market clearing, natural gas transmission system, compressed air energy storage, wind energy sources, two stage stochastic programming.

1. Introductions

At high penetration levels, uncertainty of wind energy sources (WES) in power system provides new challenges in system operation. For reducing the uncertainty of WES in power system, additional operational flexibility is needed. Operational flexibility stands for enhancing balance between generation and system load with minimum operational cost. To increase system flexibility, different approaches were presented in literature such as design of flexible ramp product market [1, 2], use of demand response [3, 4], energy storages [5, 6], electric vehicles [7, 8] and flexible power generation [9].

From the flexibility point of view, generation stations are categorized as base load generation, peaking generation, and load following generation. Examples of base load power plant are nuclear and coal-fired plants, which are generating constant power. Peaking power plants corresponds to peak load duration time. Load following power plants such as gas turbine based generation balancing instantaneous generated power and demand having more flexibility, start-up time of less than hour, and ramp-rate capability of more than 50 MW/min, while nuclear and coal-fired power plants have start-up time between 4 to 8 hours and low ramp-rate approximately 1 MW/min [10]. Besides the technical views, natural gas-fueled plants produce up to 60% less CO₂ comparing to coal-fired plants. Also, they produce no SO₂ emissions and less NO_x [11]. Based on the annual energy report in 2014, natural gas-fueled units would take over 16% of the total United State electricity generation [12]. The

rapidly increasing interdependency of gas and electricity causes new challenges in power system operation. The volatility of natural gas prices, pressure loss in the gas pipeline could directly affect the power dispatch of generating units, operation cost, and power system security.

Higher system flexibility could be achieved by energy storage investment. Compressed air energy storage (CAES) systems are considered as a large-scale energy storage for the utility application. There are two CAES systems in operation. One is in Hontrof, Germany with the capacity of 290 MW and the second one in Alabama with the capacity of 110 MW [13, 14]. The third one in Texas, U.S.A with the capacity of 317 MW would be available for operation by 2019 [15]. CAES units with very high compress ramping play important role in ancillary services market [16]. CAES drives an electric air compressor to compress the air and store in an underground cavern at low-load hours and generate electricity using gas turbine and the compressed air at high load hours [17]. This phenomenon increases the flexibility of system operation. Finally, using CAES coupled with WES reduces the impact of wind energy variability [18]. Some of reports have discussed the advantages of CAES system in power systems. In [19], the problem of network-constrained unit commitment (NCUC) with CAES system and WES has been solved to study its effect on power system operation cost. The main objective is to obtain an hourly dispatch schedule for power plants at minimum cost with electricity system constraints. Modeling for wind uncertainty/intermittency has not been considered in the paper. The effect of CAES on profit and operating cost by optimally scheduling of WES is described in [20]. Authors of [21] have presented an information gap decision theory based self-scheduling for a CAES facility considering power price uncertainty. The impact of CAES system on operating cost and static voltage stability (SVS) improvement has been studied in [22] by solving the stochastic SCUC problem. Incorporation of CAES system has been investigated in [23] to reduce the daily operation cost as well

as environmental pollution by solving a multi-objective stochastic unit commitment (UC) considering demand response (DR) programs and plug-in electric vehicle parking lots.

Some of latest researchers have focused on the day ahead network constrained scheduling of combined power and gas networks. Authors of [24] proposed a stochastic UC model for studying the interdependence of power and gas systems. Random outages of power plants and electric system lines, as well as forecast errors of load demand have been considered in the proposed model. Reserve market, energy storage system (ESS) and WES are not included in the system. Authors in [25] demonstrated the benefits of applying the price-based DR in the optimized stochastic scheduling of power network with gas system limits. In [26], the main contribution is to discuss the coordination of interdependent gas and power systems for reducing the uncertainty of WES in the stochastic day-ahead market optimization problem. This paper just contains energy market and does not contribute ESS to provide a solution for volatility and intermittency of WES. Ref [27] dedicated for a day-ahead power-natural gas operation with price-based DR considering flexible ramping products. In [28] was solved a robust co-optimization problem of coupled power and gas systems considering gas storage system. This paper has discussed the effect of gas storage on total operation cost of power and gas systems in a problem of robust day-ahead scheduling. Ref [29] has focused on the integration of power to gas technology in coupled power and gas systems with high penetration of WES which results shows considering the power to gas technology reduces WES spillage and total operating cost in day-ahead market optimization of combined power and gas networks.

A number of researchers have studied the effect of flexible resources in UC based stochastic market-clearing model of joint energy and reserve. In [30], impact of DR in NCUC problem has been investigated on energy and reserve cost. The proposed model is formulated as a two-stage stochastic programming. The first stage corresponds to network-constrained UC and the second-stage

investigates security assurance in system scenarios. In [31], the hourly reserve has been allocated for security-constrained scheduling of stochastic WES. Wind and load forecast errors are addressed through a two-stage stochastic model considering an N-1 contingency model for component outages. In [32] was solved a two-stage stochastic network constrained market-based model integrated with electric vehicles for clearing energy and reserve products, simultaneously. In [33], a stochastic co-optimization model of joint energy and reserve is proposed to coordinate the interactions among flexible providers such as ESS, electric vehicle, and price-based DR.

This paper proposes a two-stage stochastic network constrained UC based market clearing model for clearing joint energy and reserve markets in power and gas systems coupled with WES and CAES which is shown in Fig. 1. The main features of this work are summarized as follows:

- 1) The proposed model simulates both day-ahead and real-time markets in which the energy cost, scheduled reserve capacity, deployed reserve, load shedding and wind spillage are considered.
- 2) A natural gas delivery system to gas-fueled power is modeled considering gas transmission constraints. These constraints play an important role in the participation of gas-fueled power plants on energy and reserve markets.
- 3) CAES system has been used to reduce load shedding and wind spillage cost and reduce dependency on system operation cost to gas system limits.
- 4) The Monte Carlo simulation is applied in NCUC model to determine system requirements hourly reserve to cover load and wind forecast errors in real-time dispatch.

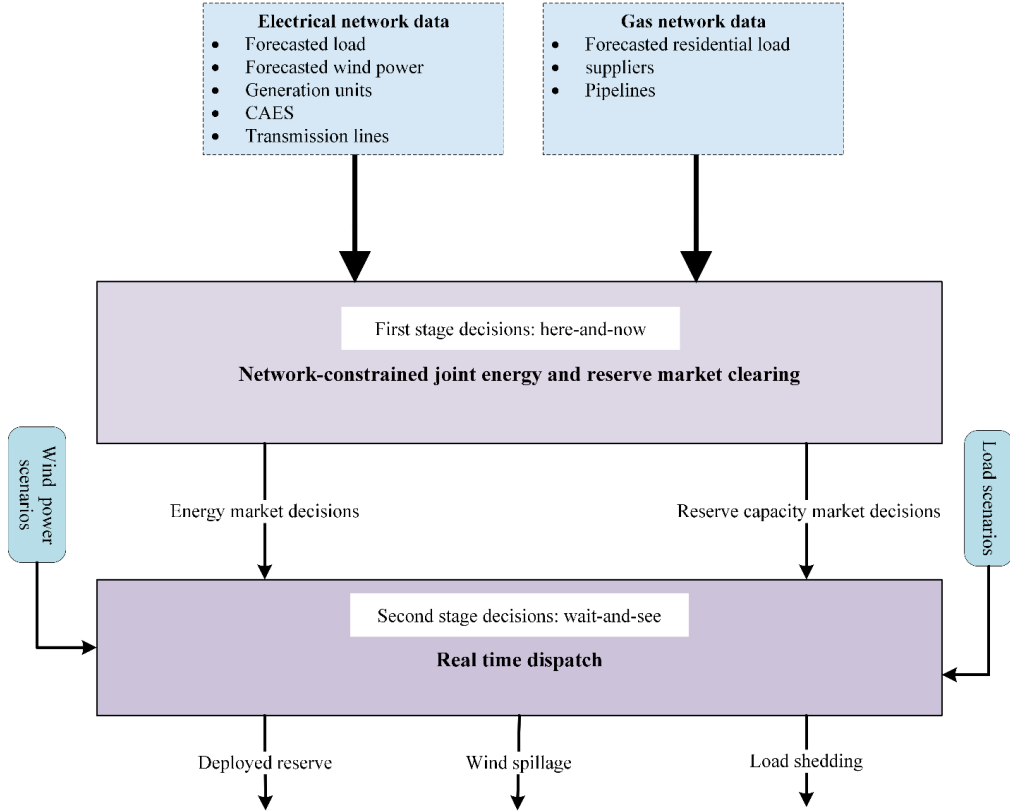

Fig. 1. The overall illustration of the proposed framework

2. Problem formulation

The formulation of the problem involves the objective function, power plants constraints, CAES and also gas network constraints in the first and second stage.

2.1. Objective Function

The proposed objective function that minimizes the cost of power system operation is expressed in Eq. (1). It is formulated as a two-stage stochastic programming, which models both the day-ahead and real-time markets. The first two lines in Eq. (1) deal with the day ahead market modeling, which includes energy cost, scheduled up and down reserve costs, start-up costs for power plants as well as costs related to offering energy and up and down-reserve by CAES. The third term in Eq. (1) which stimulates the real-time market related to the deployed up and down-

reserve costs used by power plants and CAES to cover uncertainties caused by forecasting network's load and wind and also the costs associated with the wind curtailment and loss of load in each scenario.

$$\begin{aligned}
\min & \sum_{t=1}^{NT} \sum_{i=1}^{NU} \left[F_i^C(P_{i,t}) + SU_{i,t} + C_{i,t}^{RU} R_{i,t}^U + C_{i,t}^{RD} R_{i,t}^D \right] \\
& + \sum_{t=1}^{NT} \sum_{k=1}^{NK} \left[C_{k,t}^{CA_Eng} P_{k,t}^{DIS} + C_{k,t}^{CA_RU} R_{k,t}^{CA_UP} + C_{k,t}^{CA_RD} R_{k,t}^{CA_DN} \right] \\
& \left[\sum_{i=1}^{NU} (F_i^C(P_{i,t,s}) - F_i^C(P_{i,t})) + \sum_{k=1}^{NK} (C_{k,t}^{CA_UP} r_{k,t,s}^{CA_UP} - C_{k,t}^{CA_Dn} r_{k,t,s}^{CA_DN}) \right. \\
& \left. + \sum_{r=1}^{NW} C_{r,t}^{Curt} P_{r,t,s}^{Curt} + \sum_{j=1}^{NJ} voll_{j,t} LS_{j,t,s} \right] \quad (1)
\end{aligned}$$

where t, i, k, r, j and s are indices of hours, power plants, CAES systems, wind energy sources, electric loads and scenarios, respectively, while NT, NU, NK and NS are the number of hours, power plants, CAES systems, wind energy sources, electric loads and scenarios; F_i^C is the cost function of power plant i ; $SU_{i,t}$ is the start-up cost of power plant i ; $C_{i,t}^{RU}$ and $C_{i,t}^{RD}$ are the offer costs of up and down reserves of power plant i at time t ; $C_{k,t}^{CA_Eng}$, $C_{k,t}^{CA_RU}$ and $C_{k,t}^{CA_RD}$ are the offer costs of energy, up and down reserves capacity of CAES system k ; $C_{k,t}^{CA_UP}$, $C_{k,t}^{CA_Dn}$ are the deployed up and down reserve offer costs of CAES k at time t ; $C_{r,t}^{Curt}$ is wind power spillage cost of WES r at time t ; $voll_{j,t}$ is load shedding cost of load j at time t ; $P_{i,t}$ is the dispatch of power plant i at time t ; $R_{i,t}^U$ and $R_{i,t}^D$ are up and down reserve capacity of power plant i at time t ; $P_{k,t}^{DIS}$ is the discharge power of CAES k at time t ; $R_{k,t}^{CA_UP}$ and $R_{k,t}^{CA_DN}$ are scheduled up and down reserves capacity of CAES k at time t ; $r_{k,t,s}^{CA_UP}$ and $r_{k,t,s}^{CA_DN}$ are the deployed up and down reserves of CAES k at time t and scenario s ; $P_{r,t,s}^{Curt}$ is wind power spillage of WES r at time t and scenario s ; $LS_{j,t,s}$ is load shedding of load j at time t and scenario s .

2.2. First stage constraints

The first stage constraints including the power and gas systems constraints and the constraints of interconnecting these two systems are defined as follows:

2.2.1. Power network constraints

The power network constraints including power plants, CAES and the transmission network constraints are discussed in Eqs. (2)-(29). As shown in Eqs. (2) and (3), the up- and down-reserve offered by the power plant on day ahead reserve market is dependent on the ramping capability of these units. The maximum/minimum capacity that power plant can offer to the energy and reserve markets is expressed in Eqs. (4) and (5). The limitation of power plant's ramp rate in consecutive intervals is expressed in Eqs. (6)-(9). The units must have been switched on or off for some time before being turned off or on, as expressed in Eqs. (10) and (11).

$$0 \leq R_{i,t}^U \leq R_i^{up} \tau \quad (2)$$

$$0 \leq R_{i,t}^D \leq R_i^{dn} \tau \quad (3)$$

$$P_{i,t} + R_{i,t}^U \leq P_i^{\max} I_{i,t} \quad (4)$$

$$P_{i,t} - R_{i,t}^D \geq P_i^{\min} I_{i,t} \quad (5)$$

$$P_{i,t} - P_{i,t-1} \leq (1 - Y_{i,t}) R_i^{up} + Y_{i,t} P_i^{\min} \quad (6)$$

$$P_{i,t-1} - P_{i,t} \leq (1 - Z_{i,t}) R_i^{dn} + Z_{i,t} P_i^{\min} \quad (7)$$

$$Y_{i,t} - Z_{i,t} = I_{i,t} - I_{i,t-1} \quad (8)$$

$$Y_{i,t} + Z_{i,t} \geq 1 \quad \forall i, \forall t \quad (9)$$

$$(X_{i,t-1}^{up} - T_i^{up})(I_{i,t-1} - I_{i,t}) \geq 0 \quad (10)$$

$$(X_{i,t-1}^{dn} - T_i^{dn})(I_{i,t} - I_{i,t-1}) \geq 0 \quad (11)$$

where R_i^{up} and R_i^{dn} are up and down ramp rate of power plant i ; P_i^{\max} and P_i^{\min} are maximum and minimum capacity of power plant i ; $X_{i,t-1}^{up}$ and $X_{i,t-1}^{dn}$ are up and down time of unit i at time t ; T_i^{up} and T_i^{dn} are minimum up and down time of power plant i ; $I_{i,t}$ is the commitment state of power plant i .

The up and down spinning reserve offered by the CAES system on the day ahead market also depend on the ramping capability of these plants, as shown in Eqs. (12) and (13). In Eqs. (14) and (15), the linear relationship between the compressed air and electrical power are defined. The quantities of air injected into the storage and the air released from the storage depend on the valve size and pressure limits, which are modeled as Eqs. (16) and (17). CAES system can be in the mode of production, compressor, or idling shown by Eq. (18). Eq. (19) shows that the amount of the stored air is updated every hour, in addition, the amount of the stored air in CAES system has the maximum and minimum capacities expressed in Eq. (20).

$$0 \leq R_{k,t}^{CA_UP} \leq R_k^{up} \tau \quad (12)$$

$$0 \leq R_{k,t}^{CA_DN} \leq R_k^{dn} \tau \quad (13)$$

$$P_{k,t}^{DIS} = \alpha_k^W V_{k,t}^W \quad (14)$$

$$P_{k,t}^{CH} = a_k^{ING} V_{k,t}^{ING} \quad (15)$$

$$V_{k,\min}^W I_{k,t}^W \leq V_{k,t}^W \leq V_{k,\max}^W I_{k,t}^W \quad (16)$$

$$V_{k,\min}^{ING} I_{k,t}^{ING} \leq V_{k,t}^{ING} \leq V_{k,\max}^{ING} I_{k,t}^{ING} \quad (17)$$

$$I_{k,t}^W + I_{k,t}^{ING} \leq 1 \quad (18)$$

$$A_{k,t} = A_{k,t-1} + V_{k,t}^{ING} - V_{k,t}^W \quad (19)$$

$$A_k^{\min} \leq A_{k,t} \leq A_k^{\max} \quad (20)$$

where R_k^{up} and R_k^{dn} are up and down ramp rate of CAES k ; α_k^W and α_k^{ING} are efficiency factor for producing and injecting power of CAES k ; $P_{k,t}^{CH}$ is the stored power in CAES k at time t ; $V_{k,\max}^W$ and $V_{k,\min}^W$ are maximum and minimum amount of released air of CAES k at time t ; $V_{k,\max}^{ING}$ and $V_{k,\min}^{ING}$ are maximum and minimum amount of injected air to CAES k at time t ; $I_{k,t}^W$ is the generation mode of CAES k at time t ; $I_{k,t}^{ING}$ is storage mode of CAES k at time t ; $A_{k,t}$ is stored air level of CAES k at time t ; A_k^{\max} and A_k^{\min} are maximum and minimum capacity of CAES k .

Eqs. (21)-(23) express the system power balance, dc power flow, and transmission line constraints.

$$\sum_{i=1}^{NU_b} P_{i,t} + \sum_{r=1}^{NR_b} P_{r,t} + \sum_{k=1}^{NK_b} P_{k,t}^{DIS} - \sum_{k=1}^{NK_b} P_{k,t}^{CH} - \sum_{j=1}^{NJ_b} D_{j,t} = \sum_{L=1}^{NL_b} PF_{L,t} \quad (21)$$

$$PF_{L,t} = \frac{\delta_{b,t} - \delta_{b',t}}{x_L} \quad (22)$$

$$-PF_L^{\max} \leq PF_{L,t} \leq PF_L^{\max} \quad (23)$$

where $P_{r,t}$ is wind power generation of WES r at time t ; $D_{j,t}$ is the forecasted load of load j at time t ; $PF_{L,t}$ is power flow of line L at time t ; $\delta_{b,t}$ is voltage angle of electric bus b ; x_L is reactance of line L ; PF_L^{\max} is capacity of line L . NU_b , NR_b , NK_b , NJ_b and NL_b are the number of power plants, wind energy sources, CAES systems, electric loads and electric lines connected to bus b .

2.2.2. Natural gas network constraints

Gas wells and storage facilities, compressors, pipelines, and valves are used to deliver the natural gas to retail customers. Natural gas system and its coupling constraints with the power network are discussed as follows:

2.2.2.1. Gas transportation constraints

The gas flowing through the pipeline is a function of degree two of the pressure at the two end nodes in which the constant parameter of the pipeline depends on the length, diameter, pressure, friction, and gas compositions which defined as Eqs. (24) and (25). There are two types of pipeline, passive and active. An active pipeline is the same as passive pipeline with a compressor, which increases the pressure difference between the two end nodes and increases the pipeline capacity, which is modeled as Eq. (26). As is limited the bus voltage in electric lines, the node pressure in the gas pipeline is also limited by Eq. (27). Suppliers can be gas wells or gas storage units that are fed into the respective node. Gas supply in each node has a lower and upper limit as defined in Eq. (28). Gas consumers are divided into commercial, industrial and residential loads, with higher priority residential loads. In addition, natural gas loads have high and low limit in each node, as expressed in Eq. (29). Such as the balance of power in each bus, the balance between natural gas suppliers and the consumption of natural gas in each node is expressed by Eq. (30).

$$F_{pl,t} = \text{sgn}(\pi e_{m,t}, \pi e_{n,t}) C_{m,n} \sqrt{|\pi e_{m,t}^2 - \pi e_{n,t}^2|} \quad (24)$$

$$\text{sgn}(\pi e_{m,t}, \pi e_{n,t}) = \begin{cases} 1 & \pi e_{m,t} \geq \pi e_{n,t} \\ -1 & \pi e_{m,t} \leq \pi e_{n,t} \end{cases} \quad (25)$$

$$F_{pl,t} \geq \text{sgn}(\pi e_{m,t}, \pi e_{n,t}) C_{m,n} \sqrt{|\pi e_{m,t}^2 - \pi e_{n,t}^2|} \quad (26)$$

$$\pi e_m^{\min} \leq \pi e_{m,t} \leq \pi e_m^{\max} \quad (27)$$

$$U_{sp}^{\min} \leq U_{sp,t} \leq U_{sp}^{\max} \quad (28)$$

$$GL_l^{\min} \leq GL_{l,t} \leq GL_l^{\max} \quad (29)$$

$$\sum_{sp=1}^{NGS_m} U_{sp,t} - \sum_{l=1}^{NGL_m} GL_{l,t} = \sum_{pl=1}^{NPL_m} F_{pl,t} \quad (30)$$

where $F_{pl,t}$ is gas flow of pipeline pl ; $\pi_{e_{m,t}}$ and $\pi_{e_{n,t}}$ are pressure of gas nodes m and n at time t ; $C_{m,n}$ is constant of pipe pl ; $\pi_{e_m}^{\max}$ and $\pi_{e_m}^{\min}$ are minimum and maximum pressure of gas node m ; $U_{sp,t}$ is gas supply of gas supplier sp at time t ; U_{sp}^{\max} and U_{sp}^{\min} are maximum and minimum gas supply of gas supplier sp ; GL_l^{\max} and GL_l^{\min} are maximum and minimum gas consumption of gas load l ; $GL_{l,t}$ is gas consumption of gas load l at time t ; NGS_m , NGL_m and NPL_m are the number of gas suppliers, gas loads and pipelines connected to gas node m .

2.2.2.1. Power and gas networks coupling constraints

Gas-fueled power plants and CAES are the largest industrial users of gas, whose production capacity in these units is dependent on natural gas transmission services. The amount of gas consumed by the gas fueled power plants and the CAES to generate electric power is reported in (31)-(32). Natural gas-fueled power plants and CAES have a large load consumption role for the gas system (33)-(34). The daily consumption of natural gas by these units should not exceed the limit (35)-(36).

$$F_{i,t}^{gasunit} = \alpha_i + \beta_i P_{i,t} + \gamma_i P_{i,t}^2 \quad i \in NGU \quad (31)$$

$$F_{k,t}^{CAES} = HR_k P_{k,t}^{DIS} \quad (32)$$

$$L_{l,t} = F_{i,t}^{gasunit} \quad \forall l = i, \dots, NGU \quad (33)$$

$$L_{l,t} = F_{k,t}^{CAES} \quad \forall l = k, \dots, NK \quad (34)$$

$$\sum_{t=1}^{NT} F_{k,t}^{CAES} \leq FC_k^{\max} \quad (35)$$

$$\sum_{t=1}^{NT} F_{i,t}^{gasunit} \leq FU_i^{\max} \quad (36)$$

where $F_{i,t}^{gasunit}$ and $F_{k,t}^{CAES}$ are fuel consumption of gas-fueled power plant i and CAES k at time t ; α_i, β_i and γ_i are fuel function coefficient of gas-fueled power plant i ; HR_k is heat rate of CAES k ; NGU and NK are the number of gas fired units and CAES systems, respectively; FC_k^{\max} and FU_i^{\max} are daily gas-fueled consumption of gas-fired unit i and CAES k , respectively.

2.3. Second stage constraints

In the second stage, the scenarios related to the load and wind forecast error are considered. In this section, the effects of scheduled variables in the first stage are evaluated on load and wind generated scenarios. The second stage constraints which are considered in each scenario are as follows:

$$0 \leq r_{i,t,s}^U \leq R_{i,t}^U \quad (37)$$

$$0 \leq r_{i,t,s}^D \leq R_{i,t}^D \quad (38)$$

$$0 \leq r_{k,t,s}^{CA_UP} \leq R_{k,t}^{CA_UP} \quad (39)$$

$$0 \leq r_{k,t,s}^{CA_DN} \leq R_{k,t}^{CA_DN} \quad (40)$$

$$P_{i,t,s} = P_{i,t} + r_{i,t,s}^U - r_{i,t,s}^D \quad (41)$$

$$P_{k,t,s}^{DIS} = P_{k,t}^{DIS} + r_{k,t,s}^{CA_UP} \quad (42)$$

$$P_{k,t,s}^{CH} = P_{k,t}^{CH} + r_{k,t,s}^{CA_RD} \quad (43)$$

$$P_{i,t,s} - P_{i,t-1,s} \leq (1 - Y_{i,t}) R_i^{up} + Y_{i,t} P_i^{\min} \quad (44)$$

$$P_{i,t-1,s} - P_{i,t,s} \leq (1 - Z_{i,t}) R_i^{dn} + Z_{i,t} P_i^{\min} \quad (45)$$

$$P_{k,t,s}^{DIS} = \alpha_k^W V_{k,t,s}^W \quad (46)$$

$$P_{k,t,s}^{CH} = \alpha_k^{ING} V_{k,t,s}^{ING} \quad (47)$$

$$V_{k,\min}^W I_{k,t}^W \leq V_{k,t,s}^W \leq V_{k,\max}^W I_{k,t}^W \quad (48)$$

$$V_{k,\min}^{ING} I_{k,t}^{ING} \leq V_{k,t,s}^{ING} \leq V_{k,\max}^{ING} I_{k,t}^{ING} \quad (49)$$

$$A_{k,t,s} = A_{k,t-1,s} + V_{k,t,s}^{ING} - V_{k,t,s}^W \quad (50)$$

$$A_k^{\min} \leq A_{k,t,s} \leq A_k^{\max} \quad (51)$$

$$A_{k,0} = A_{k,s,0} = A_{k,s,NT} \quad (52)$$

$$\sum_{i=1}^{NU_b} P_{i,t,s} + \sum_{k=1}^{NK_b} (P_{k,t,s}^{DIS} - P_{k,t,s}^{CH}) + \sum_{r=1}^{NR_b} (P_{r,t,s} - P_{r,t,s}^{Curt}) - \sum_{j=1}^{NJ_b} (D_{j,t,s} - LS_{j,t,s}) = \sum_{L=1}^{NL_b} PF_{L,t,s} \quad (53)$$

$$PF_{L,t,s} = \frac{\delta_{b,t,s} - \delta_{b',t,s}}{x_L} \quad (54)$$

$$-PF_L^{\max} \leq PF_{L,t,s} \leq PF_L^{\max} \quad (55)$$

$$0 \leq P_{r,t,s}^{Curt} \leq P_{r,t,s} \quad (56)$$

$$0 \leq LS_{j,t,s} \leq D_{j,t,s} \quad (57)$$

$$F_{pl,t,s} = \text{sgn}(\pi e_{m,t,s}, \pi e_{n,t,s}) C_{m,n} \sqrt{|\pi e_{m,t,s}^2 - \pi e_{n,t,s}^2|} \quad (58)$$

$$\text{sgn}(\pi e_{m,t,s}, \pi e_{n,t,s}) = \begin{cases} 1 & \pi e_{m,t,s} \geq \pi e_{n,t,s} \\ -1 & \pi e_{m,t,s} \leq \pi e_{n,t,s} \end{cases} \quad (59)$$

$$F_{pl,t,s} \geq \text{sgn}(\pi e_{m,s,t}, \pi e_{n,s,t}) C_{m,n} \sqrt{|\pi e_{m,s,t}^2 - \pi e_{n,s,t}^2|} \quad (60)$$

$$\pi e_m^{\min} \leq \pi e_{m,t,s} \leq \pi e_m^{\max} \quad (61)$$

$$U_{sp}^{\min} \leq U_{sp,t,s} \leq U_{sp}^{\max} \quad (62)$$

$$GL_l^{\min} \leq GL_{l,t,s} \leq GL_l^{\max} \quad (63)$$

$$\sum_{sp=1}^{NGS_m} U_{sp,t,s} - \sum_{l=1}^{NGL_m} GL_{l,t,s} = \sum_{pl=1}^{NPL_m} F_{pl,t,s} \quad (64)$$

$$F_{i,t,s}^{gasunit} = \alpha_i + \beta_i P_{i,t,s} + \gamma_i P_{i,t,s}^2 \quad (65)$$

$$GL_{l,t,s} = F_{i,t,s}^{gasunit} \quad \forall l = i, \dots, NGU \quad (66)$$

$$F_{k,t,s}^{CAES} = HR_k P_{k,t,s}^{DIS} \quad (67)$$

$$GL_{l,t,s} = F_{k,t,s}^{CAES} \quad \forall l = k, \dots, NK \quad (68)$$

$$\sum_{t=1}^{NT} F_{i,t,s}^{gasunit} \leq FU_i^{\max} \quad (69)$$

$$\sum_{t=1}^{NT} F_{k,t,s}^{CAES} \leq FC_K^{\max} \quad (70)$$

In Eqs. (37)-(40) show the relationship between the deployed reserve in the second stage with the scheduled reserve capacity in the first stage. The deployed reserve in each scenario cannot exceed the scheduled reserve of power plants and CAES system in the first stage. The power generated by power plants and CAES system in each scenario is obtained as the sum of scheduled power at the first stage and the deployed reserve in the second stage that is shown in Eqs. (41)-(43). The limitation of power plant's ramp rate in consecutive intervals and each scenario is expressed in Eqs. (44)-(45). The relationship between the compressed air and electrical power in each scenario are expressed in Eqs. (46) and (47). The quantities limits of air injected into the storage and the air

released from the storage in each scenario are defined as Eqs. (48) and (49). In addition, Eq. (50) expresses that the amount of the stored energy in CAES system is updated in every hour and scenario. Also, the amount constraint of the stored energy in CAES in each scenario system is expressed as Eq. (51). Also, the initial and final values of stored air in each scenario and in a cycle must be equal to each other that is shown in (52). As presented in (27)-(29), the power balance constraints in each scenario are expressed in terms of (53)-(55). If a deployed reserve in each scenario fails to provide network security, we will be obliged to the compulsory load shedding in the system, the limitation of load shedding and curtailed wind power in each scenario is shown in (56) and (57). As expressed in Eqs (24)-(36), gas system constraints, and also electricity and natural gas networks coupling constraints in each scenario are defined as Eqs. (58)-(70).

3. Numerical simulations

In this paper, we have used two test systems, electric six-bus system with a gas six-node system and IEEE reliability test system (RTS) 24-bus system with a gas ten-node system, taking into account a WES and CAES for testing the proposed model. The effect of the constraints of gas systems and CAES on energy, reserve, wind curtailment and lost load costs have been studied. The proposed mixed integer non-linear programming (MINLP) model is implemented in generalized algebraic modeling systems (GAMS) software and solved using standard branch and bound (SBB) solver.

3.1. Modified six-bus system

The modified 6-bus system consists of three gas-fueled power plants with seven lines and three electric loads that the specifications of units, bus and lines and hourly load distribution are summarized in [11]. In addition, a WES with the maximum capacity of 35 MW and a CAES unit

are placed in bus 5, respectively. The 6-node system of natural gas network includes 5 pipes, 1 compressor, 2 gas suppliers and 6 loads, which is given in Fig. 2. Gas loads consist of three natural gas-fueled power plants, a CAES system and two other types of load. Scenario set based on Monte Carlo simulation has been produced for modeling system uncertainties, including the error of load and network wind forecasting. To demonstrate the network load and WES forecasting errors, the normal distribution function is used [29]. To reduce the 1000 scenarios generated to ten scenarios, SCENRED is used which is a tool provided by GAMS software. The standard deviation of the network load and WES from their mean value have considered 5% and 6%, respectively. Also, wind spillage and load shedding costs are equal to 50 \$/MWh and 400 \$/MWh, respectively. The offered energy cost of the natural gas-fueled power plants is equal their fuel coefficients [24]. The cost of the scheduled up/down reserve capacity by the gas-fueled thermal units G1, G3 and G2 are 8, 10 and 11 \$/MW, respectively. Also, the cost of start-up proposed by three units is equal 500 \$/MW. The cost of energy offered by CAES unit is equal 4.5 \$/MWh. And the scheduled up/down reserve capacity cost by CAES unit is equal to 40% of the proposed energy cost by this unit.

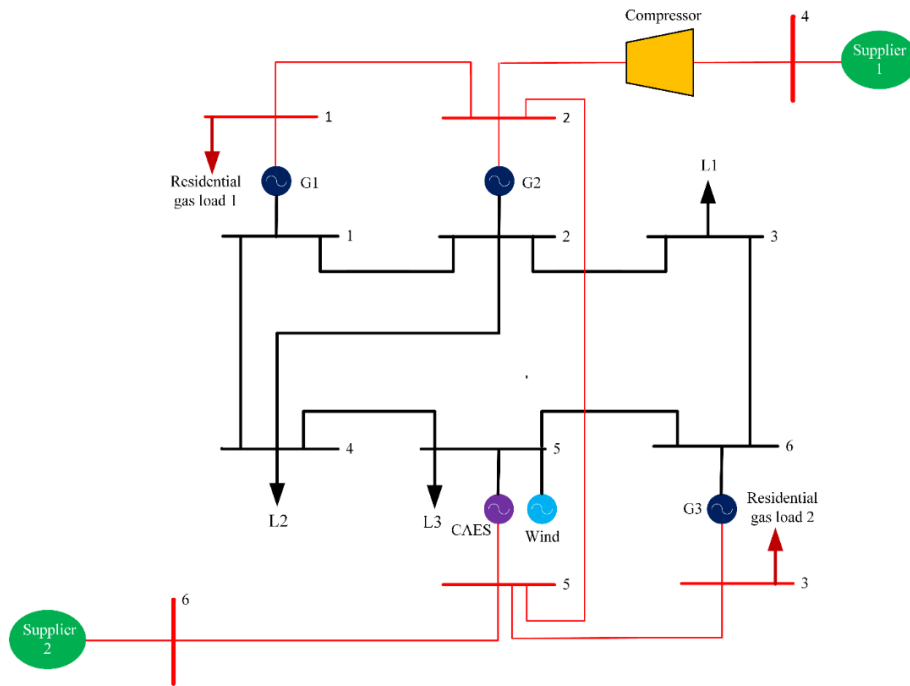

Fig. 2. Illustration of 6-bus electrical and 6-node natural gas systems with WES and CAES units

The following three case studies are considered:

1. Simultaneous clearing of energy market and reserve, without considering the constraints of the gas system.
2. Simultaneous clearing of energy market and reserve with considering the constraints of the gas system.
3. Simultaneous clearing of energy market and reserve with considering the constraints of the gas system and CAES.

Case 1. In this case, the constraints of gas system are ignored. The network wind profile for 24-h horizon is shown in Fig. 3. As shown in Fig. 4, the low cost unit G1 is committed over the entire period, while the high cost unit G2 is committed during hours 15-18, which are peak hours, also unit G3 runs from hours 12 to 21. According to the Figs. 5 and 6, at peak hours, most of up/down

reserve capacity is provided by the expensive unit G2, during other hours, units G1 and G3 have provided up/down reserve capacity. It is noteworthy that during hours 16 and 17, the up reserve capacity required to cover the network load and wind forecast errors are equal to 10.937 and 10.948 MW, while the congestion of the transmission lines has caused that the capacity of the scheduled up reserve would be more than required up reserve. Also, most of load shedding has happened during hours 11, 14 and 18, because it is more economical to curtail loads instead of committing more expensive unit. Expected load shedding and wind curtailment in this case are 3.835 and 6.66 MWh respectively. The total cost of the operating, in this case, is \$73505.86 which includes \$68222.10 cost of energy and \$2678.16 scheduled reserve capacity costs.

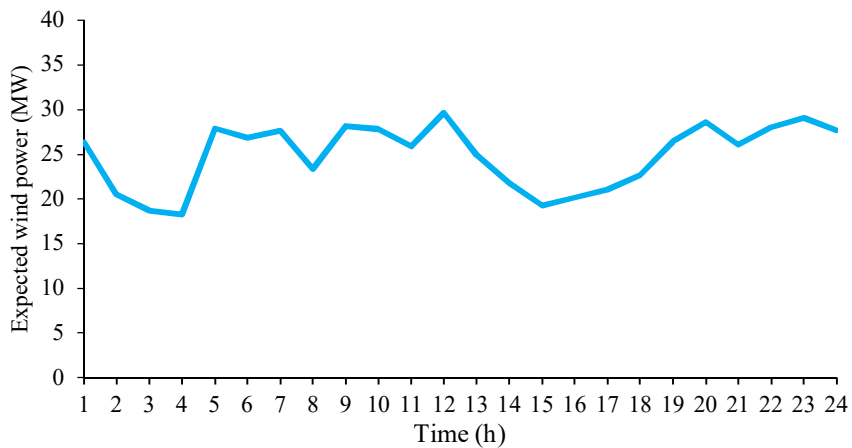

Fig. 3. Expected wind power of the network

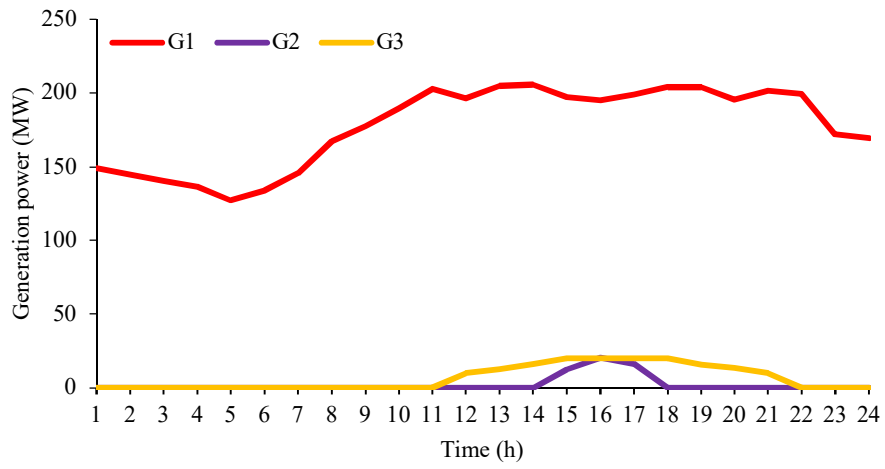

Fig. 4. Hourly power generation dispatch for case 1

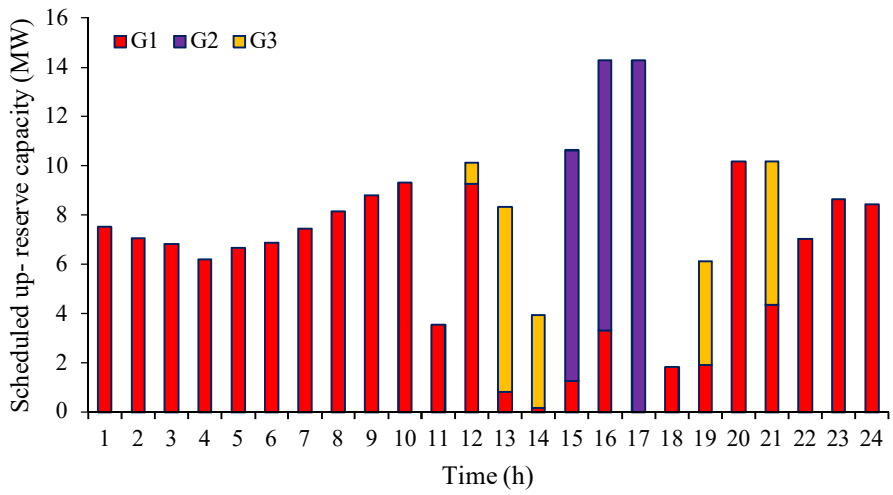

Fig. 5. Scheduled up reserve provided by three thermal units for case 1

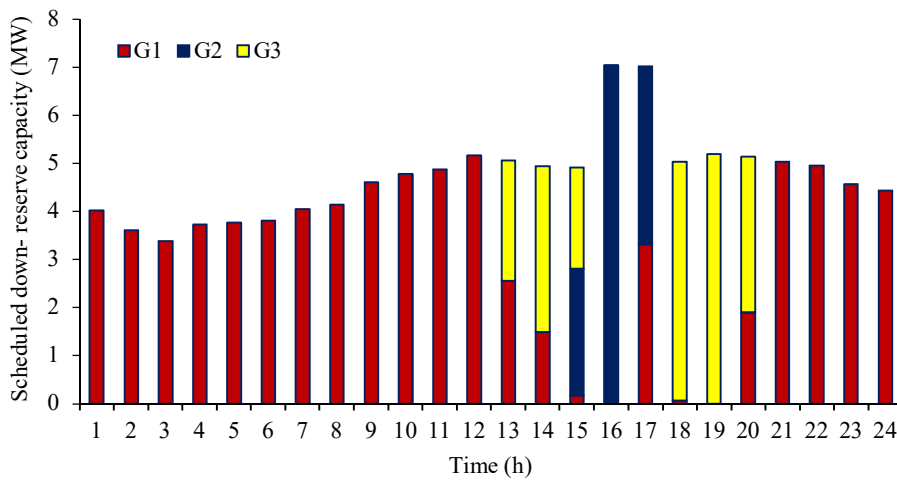

Fig. 6. Scheduled down reserve provided by three thermal units for case 1

Case 2. In this case, gas system limits are considered. The comparison of the power dispatch of units G1 and G2 with case 1 is shown in Fig. 7. Considering the limitation of gas transmission has reduced power dispatch of unit G1 which resulted in an increase in the power dispatch of units G2 and G3. Total power dispatch of units G2 is increased from 49.247 MWh in case 1 to 294.75 MW in case 2. In addition, as shown in Figs. 8 and 9, taking the constraints of the gas system into account has reduced the participation of unit G1 in the reserve market. Scheduled up/down reserve capacity by unit G1 has decreased from 135.67 and 81.585 MWh in case 1 to 76.947 and 49.998 MWh in case 2 respectively. In addition, the congestion of gas pipeline has caused an involuntary load shedding occurrence during hours 16 and 17 in the system. Load shedding in this case is decreased to 2.755MWh, due to the increase in participation of plants. However, wind spillage has increased to 6.93 MWh. The total cost of operating is \$80115.16, which includes \$76024.27 energy cost and \$2931.05 scheduled reserve capacity cost that has increased significantly compared to case 1.

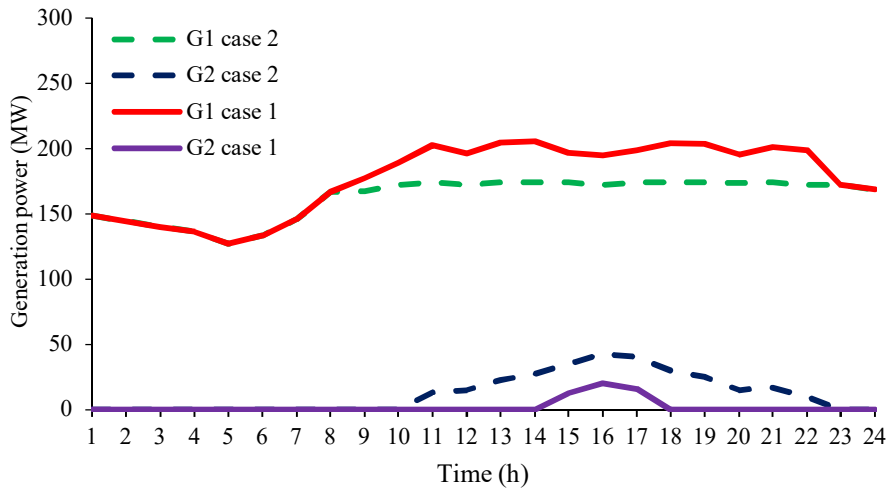

Fig. 7. Hourly power generation dispatch of G1 and G2 for cases 1 and 2

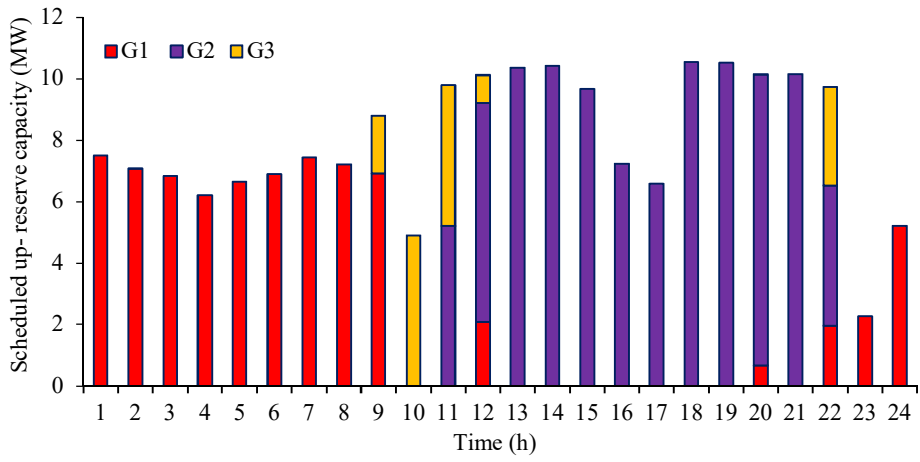

Fig. 8. Scheduled up reserve provided by three thermal units for case 2

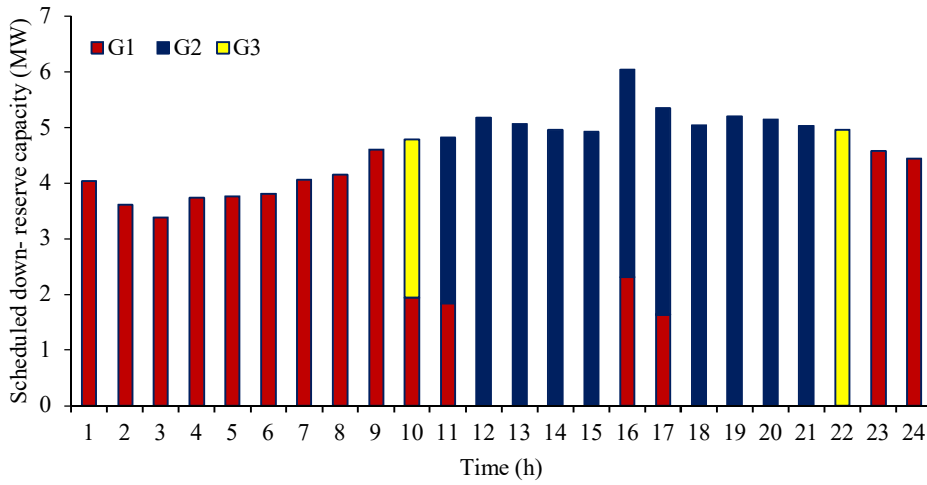

Fig. 9. Scheduled down reserve provided by three thermal units for case 2

Case 3. In this case, a CAES system with a maximum generation power of 30 MW is placed in bus 5. CAES unit's specification is given in Table 1. The effect of CAES unit on the power dispatch of plants G1 and G2 compared with case 2 is shown in Fig. 10. During the low load hours, CAES is in charging mode and generation power of unit G1 has increased compared to case 2. For the hours that network load is high, CAES is in discharging mode. In this interval, the generation power of G2 has decreased about 30% compared with case 2. The CAES system at hour 13 is committed to discharge mode to reduce load shedding. The effect of the commitment of CAES unit in the reserve market on the up and down reserve capacity scheduled by gas-fueled power plants is shown in Figs. 11 and 12. The required down reserve capacity will be provided by CAES system when it is in charge mode. In this interval, up reserve capacity scheduled by gas-fueled power plants has been increased compared to case 2. On the other hand, most of the needed up reserve capacity is provided by CAES system when it is in discharge mode. The scheduled up reserve capacity by unit G2 is 75.173 MWh that has been reduced compared with the previous case. In addition, the effect of CAES unit on reducing the wind curtailment is shown in Fig. 13. Wind curtailment in this case has decreased to 3.782 MWh. It is noticeable that

the commitment of CAES unit in both charge and discharge mode in the reserve market has caused a decrease in wind curtailment. The load shedding in this case is equal to 0.49 MWh that has had a noticeable decrease compared with two previous cases. Also, as shown in Fig. 14, the total cost of the operation in this case is equal \$77624.34, which is lower than case 2.

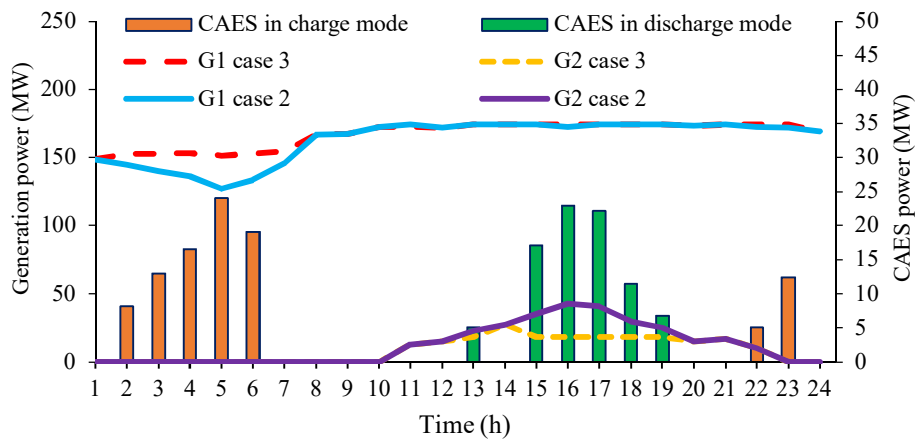

Fig. 10. Effect of CAES unit on hourly power generation dispatch of G1 and G2

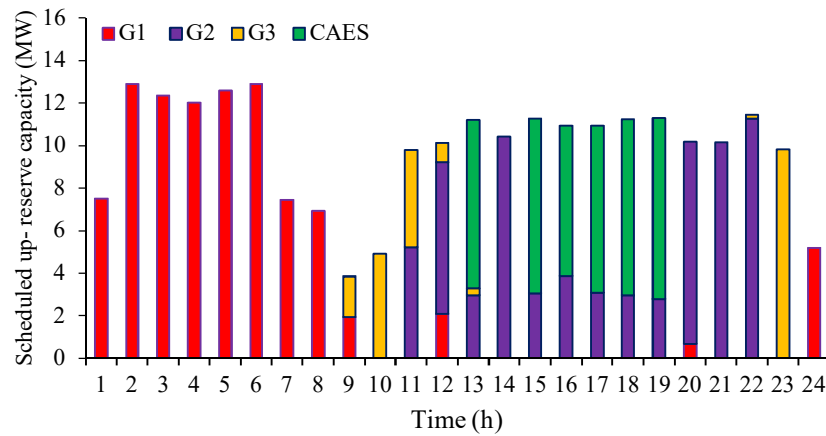

Fig. 11. Scheduled up reserve provided by three thermal units for case 3

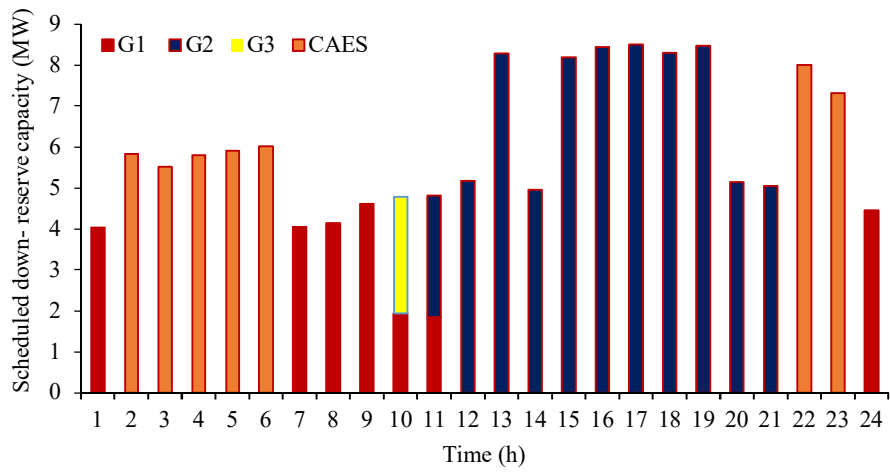

Fig. 12. Scheduled down reserve provided by three thermal units for case 3

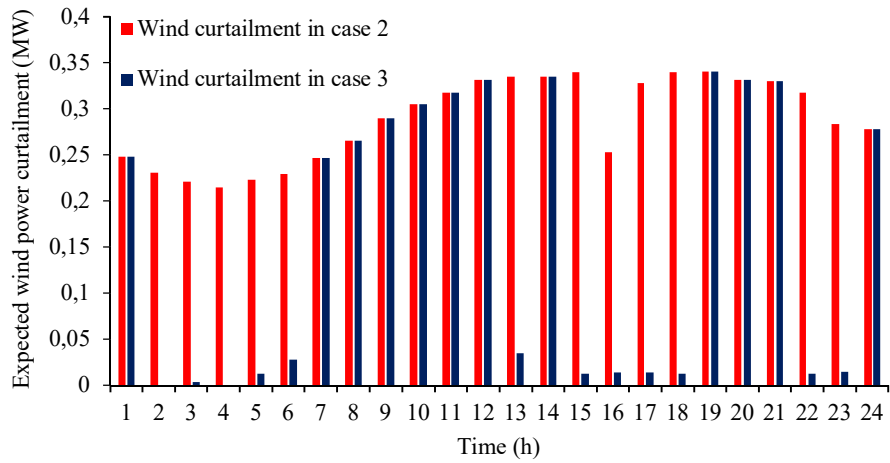

Fig. 13. Effect of CAES on the wind curtailment

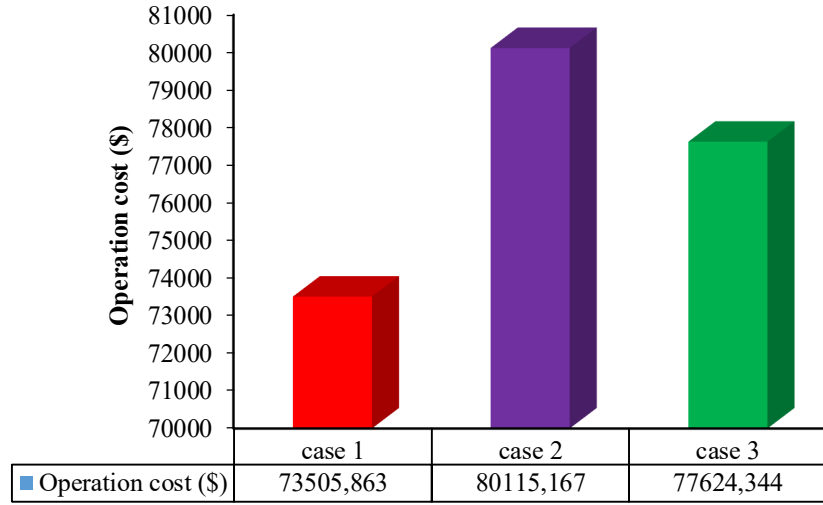

Fig. 14. Effect of CAES unit and considering gas transmission constraints on daily operation cost

Table. 1. Specification parameters of CAES unit in the 6-bus system

$A_{k,t}^{\max}$	$A_{k,t}^{\min}$	$V_{k,\max}^W$	$V_{k,\min}^W$	$V_{k,\max}^{ING}$	$V_{k,\min}^{ING}$
180	40	30	5	30	5

3.2. Modified IEEE-RTS 24-bus system

The modified IEEE-RTS 24-bus system has 34 power plants including 8 gas-fueled power plants, 26 units of other types, 34 branches and 17 load buses. In addition, two wind farms with a capacity of 500 MW at buses 6 and 23 and two CAES units with a maximum output power of 50 MW are located at buses 6 and 23. The specifications of the CAES units is as same the pervious case. In addition, eight natural gas-fueled units are located at the buses 4, 6, 8, 10, 12, 15, 18 and 19, respectively. Specifications relating to network load, transmission lines and 26 non-natural gas units are mentioned in [34, 35]. In this study, the total capacity of 26 non-natural gas units has decreased by 10%. In addition, the capacity of lines 2-6 and 6-10 has increased to 200 MW. The ten-node system of the natural gas network consists of 10 pipelines, 14 loads of natural gas and two compressors, which is shown in Fig. 15. Natural gas loads consist of eight natural gas-fueled units, two CAES units and four other types of loads. The specifications of the natural gas network

and gas-fueled power plants are expressed in [27]. The cost of up/down reserve capacity offered by the units is about 40% of their first-order coefficients. Monte Carlo simulation has been applied to model the uncertainties due to the load and network wind forecast. Wind and network load errors in this study were considered to be 6% and 5%, respectively. In addition, the cost of the load shedding and wind spillage is equal to 400 \$/MWh and 50 \$/MWh, respectively. The cost of energy and the up/down reserve capacity provided by the two CAES systems are considered to be 4.5 \$/MWh and 1.8 \$/MW, respectively. The effect of gas system constraints and CAES on the operating cost has been shown in Table 2. In case 1, the gas system constraints are ignored. In this case, the total operating cost is \$605814.78. In case 2, the gas system constraints are considered; in this case, the total operation cost has increased to \$620584.91, which includes \$591513.43 energy cost and \$22427.26 reserve (total scheduled reserve capacity and deployed reserve) cost. In addition, the cost of load shedding has fallen to \$4890.08, this decrease is due to the increase participation of units. In addition, the cost of wind curtailment is the same cost of case 1. The effect of CAES units participation in the reserve and energy markets on system operating cost, load shedding and wind spillage considering the constraints of the gas system has been investigated in case 3. The cost of load shedding and wind spillage have decreased to \$1785.53 and \$218.05 respectively. In addition, the total cost of the daily operation has fallen to \$610731.11, which includes \$584473.09 energy costs and \$24255.44 reserve cost.

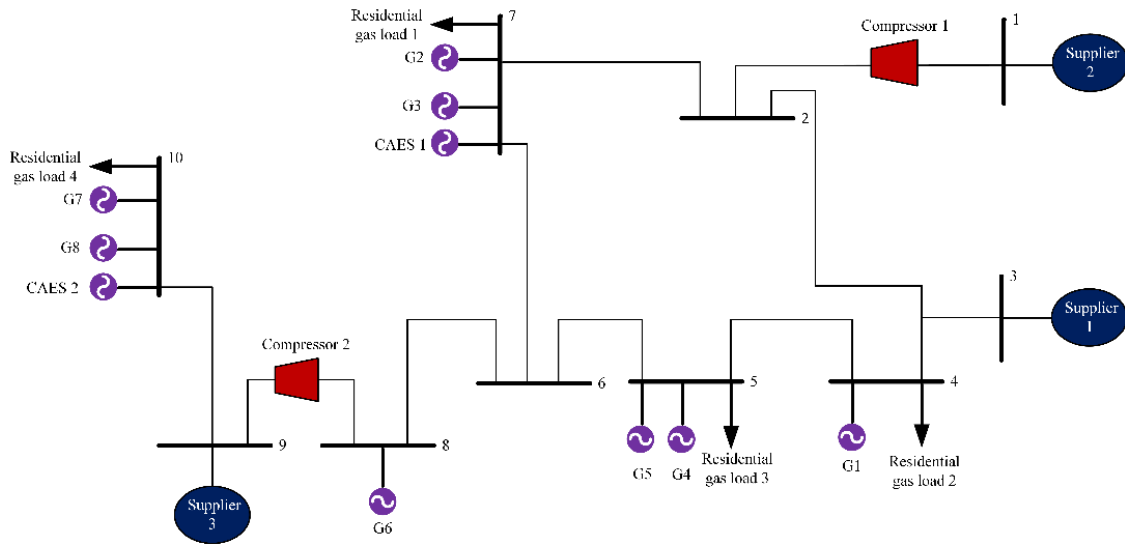

Fig. 15. Ten-node natural gas system

Table. 2. The IEEE-RTS costs

Case	Daily Operation cost (\$)	Energy cost (\$)	Cost of reserve (\$)	Cost of load shedding (\$)	Cost of wind spillage (\$)
Case 1	605814.78	578898.11	20186.20	4976.33	1754.14
Case 2	620584.91	591513.43	22427.26	4890.08	1754.14
Case 3	610732.11	584473.09	24255.44	1785.53	218.05

4. CONCLUSION

This paper presented a stochastic network-constrained co-optimization of energy and reserve products considering gas system constraints with WES and compressed air energy storage (CAES). The presented stochastic model has been formulated as a two-stage stochastic programming problem that simulates both day-ahead and real-time markets in which the energy cost, scheduled reserve capacity, deployed reserve, load shedding and wind spillage were considered. In order to cover the uncertainties caused by forecast errors in the load and network wind has used flexible recourses with fast start

capability. In this paper, flexible resources are including natural gas-fueled power plants and CAES. In addition, we have modeled the delivery system of natural gas to gas-fueled power plants as gas system constraints. The effect of considering these constraints on the participation of gas-fueled power plant in the energy and reserve markets and also power dispatch of this units have been investigated, which results showed an increase in the system energy and reserve costs. In addition, the effects of CAES participation in the energy and reserve markets on hourly dispatch of units, wind power dispatch and load shedding have been analyzed that results showed a decrease in the daily operation cost, curtailed wind power and load shedding. In our future research, we will focus especially on the multi-objective market clearing of joint energy and reserve in multi-carrier energy systems as an economic and environmental scheme in which emission function is considered as a new objective in the proposed model.

REFERENCES

- [1]Heydarian-Forushani E, Golshan MEH, Shafie-khah M, Siano P. Optimal Operation of Emerging Flexible Resources Considering Sub-Hourly Flexible Ramp Product. *IEEE Transactions on Sustainable Energy*. 2018;9:916-29.
- [2]Cui M, Zhang J, Wu H, Hodge B-M. Wind-friendly flexible ramping product design in multi-timescale power system operations. *IEEE Transactions on Sustainable Energy*. 2017;8:1064-75.
- [3]Nazari-Heris M, Abapour S, Mohammadi-Ivatloo B. Optimal economic dispatch of FC-CHP based heat and power micro-grids. *Applied Thermal Engineering*. 2017;114:756-69.
- [4]Shafie-Khah M, Mahmoudi N, Siano P, Saha TK, Catalao JP. A comprehensive model to integrate emerging resources from supply and demand sides. *IEEE Transactions on Smart Grid*. 2018;9:3883-96.
- [5]Ren J, Ren X. Sustainability ranking of energy storage technologies under uncertainties. *Journal of Cleaner Production*. 2018;170:1387-98.
- [6]Hemmati R. Optimal design and operation of energy storage systems and generators in the network installed with wind turbines considering practical characteristics of storage units as design variable. *Journal of Cleaner Production*. 2018;185:680-93.
- [7]Raugei M, Hutchinson A, Morrey D. Can electric vehicles significantly reduce our dependence on non-renewable energy? Scenarios of compact vehicles in the UK as a case in point. *Journal of Cleaner Production*. 2018;201:1043-51.

- [8]Yu L, Li Y. A flexible-possibilistic stochastic programming method for planning municipal-scale energy system through introducing renewable energies and electric vehicles. *Journal of Cleaner Production*. 2019;207:772-87.
- [9]Shavel I, Yang Y, Lueken R, O'Brien A, McIntyre C. The Value of Flexible Generation in ERCOT with High Renewable Penetration. Available: <http://blogs.edf.org/texascleanairmatters/files/2016/05/Brattle-IV-Executive-Summary-Final-17-may-2016.pdf>.
- [10]Heinen S, Hewicker C, Jenkins N, McCalley J, O'Malley M, Pasini S, et al. Unleashing the Flexibility of Gas: Innovating Gas Systems to Meet the Electricity System's Flexibility Requirements. *IEEE Power and Energy Magazine*. 2017;15:16-24.
- [11]Alabdulwahab A, Abusorrah A, Zhang X, Shahidehpour M. Stochastic security-constrained scheduling of coordinated electricity and natural gas infrastructures. *IEEE Systems Journal*. 2017;11:1.83-674
- [12]Cui H, Li F, Hu Q, Bai L, Fang X. Day-ahead coordinated operation of utility-scale electricity and natural gas networks considering demand response based virtual power plants. *Applied Energy*. 2016;176:183-95.
- [13]Biasi V. 110 MW McIntosh CAES plant over 90% availability and 95% reliability. *Gas Turbine World*. 1998;28:26-8.
- [14]Weber O. AIR-STORAGE GAS-TURBINE POWER-STATION AT HUNTORF. *Brown Boveri Review*. 1975;62:332-7.
- [15]Mohammadi A, Mehrpooya M. Exergy analysis and optimization of an integrated micro gas turbine, compressed air energy storage and solar dish collector process. *Journal of cleaner production*. 2016;139:372-83.
- [16]Beaudin M, Zareipour H, Schellenberglobe A, Rosehart W. Energy storage for mitigating the variability of renewable electricity sources: An updated review. *Energy for Sustainable Development*. 2010;14:302-14.
- [17]Jabari F, Nojavan S, Ivatloo BM. Designing and optimizing a novel advanced adiabatic compressed air energy storage and air source heat pump based μ -Combined Cooling, heating and power system. *Energy*. 2016;116:64-77.
- [18]de Boer HS, Grond L, Moll H, Benders R. The application of power-to-gas, pumped hydro storage and compressed air energy storage in an electricity system at different wind power penetration levels. *Energy*. 2014;72:360-70.
- [19]Daneshi H, Srivastava A. Security-constrained unit commitment with wind generation and compressed air energy storage. *IET Generation, Transmission & Distribution*. 2012;6:167-75.
- [20]Abbaspour M, Satkin M, Mohammadi-Ivatloo B, Lotfi FH, Noorollahi Y. Optimal operation scheduling of wind power integrated with compressed air energy storage (CAES). *Renewable Energy*. 2013;51:53-9.
- [21]Shafiee S, Zareipour H, Knight AM, Amjady N, Mohammadi-Ivatloo B. Risk-constrained bidding and offering strategy for a merchant compressed air energy storage plant. *IEEE Transactions on Power Systems*. 2017;32:946-57.

- [22]Ghaljehei M, Ahmadian A, Golkar MA, Amraee T, Elkamel A. Stochastic SCUC considering compressed air energy storage and wind power generation: A techno-economic approach with static voltage stability analysis. *International Journal of Electrical Power & Energy Systems*. 2018;100:489-507.
- [23]Soltani Z, Ghaljehei M, Gharehpetian G, Aalami H. Integration of smart grid technologies in stochastic multi-objective unit commitment: An economic emission analysis. *International Journal of Electrical Power & Energy Systems*. 2018;100:565-90.
- [24]Alabdulwahab A, Abusorrah A, Zhang X, Shahidehpour M. Stochastic security-constrained scheduling of coordinated electricity and natural gas infrastructures. *IEEE Systems Journal*. 2015.
- [25]Zhang X, Shahidehpour M, Alabdulwahab A, Abusorrah A. Hourly electricity demand response in the stochastic day-ahead scheduling of coordinated electricity and natural gas networks. *IEEE Transactions on Power Systems*. 2016;31:592-601.
- [26]Alabdulwahab A, Abusorrah A, Zhang X, Shahidehpour M. Coordination of interdependent natural gas and electricity infrastructures for firming the variability of wind energy in stochastic day-ahead scheduling. *IEEE Transactions on Sustainable Energy*. 2015;6:606-15.
- [27]Zhang X, Che L, Shahidehpour M, Alabdulwahab A, Abusorrah A. Electricity-natural gas operation planning with hourly demand response for deployment of flexible ramp. *IEEE Transactions on Sustainable Energy*. 2016;7:996-1004.
- [28]He Y, Shahidehpour M, Li Z, Guo C, Zhu B. Robust constrained operation of integrated electricity-natural gas system considering distributed natural gas storage. *IEEE Transactions on Sustainable Energy*. 2018;9:1061-71.
- [29]Chuan H, Tianqi L, Lei W, SHAHIDEHPOUR M. Robust coordination of interdependent electricity and natural gas systems in day-ahead scheduling for facilitating volatile renewable generations via power-to-gas technology. *Journal of Modern Power Systems and Clean Energy*. 2017;5:375-88.
- [30]Parvania M, Fotuhi-Firuzabad M. Demand response scheduling by stochastic SCUC. *IEEE Transactions on smart grid*. 2010;1:89-98.
- [31]Sahin C, Shahidehpour M, Erkmén I. Allocation of hourly reserve versus demand response for security-constrained scheduling of stochastic wind energy. *IEEE Transactions on Sustainable Energy*. 2013;4:219-28.
- [32]Heydarian-Forushani E, Golshan M, Shafie-khah M. Flexible interaction of plug-in electric vehicle parking lots for efficient wind integration. *Applied energy*. 2016;179:338-49.
- [33]Heydarian-Forushani E, Golshan M, Siano P. Evaluating the benefits of coordinated emerging flexible resources in electricity markets. *Applied Energy*. 2017;199:142-54.
- [34]Wang S, Shahidehpour S, Kirschen DS, Mokhtari S, Irisarri G. Short-term generation scheduling with transmission and environmental constraints using an augmented Lagrangian relaxation. *IEEE Transactions on Power Systems*. 1995;10:1294-301.
- [35]Force RT .The IEEE reliability test system-1996. *IEEE Trans Power Syst*. 1999;14:1010-20.